

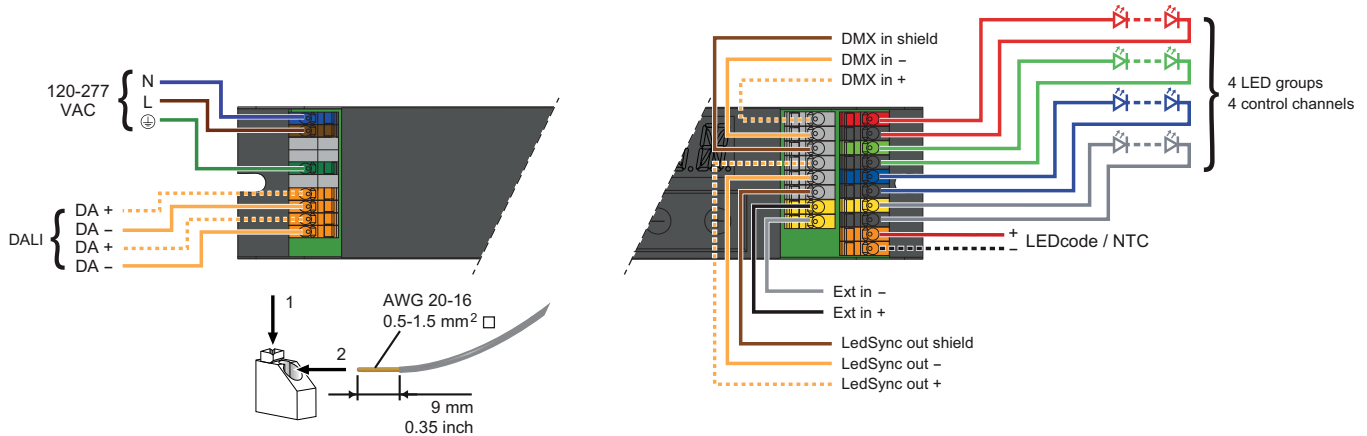

Pay attention when connecting the LED groups:

- polarity reversal results in no light output and often damages the LEDs
- combining + and - of different groups damages the driver



WARNING: Risk of electrical shock. May result in serious injury or death. Disconnect power before servicing or installing.



CAUTION: The device may only be connected and installed by a qualified electrician. All applicable regulations, legislation and building codes must be observed. Incorrect installation of the device can cause irreparable damage to the device and the connected LEDs.

120-277VAC

The driver accepts a universal mains voltage input of 120-277VAC, 50/60Hz.

DALI

Use these connectors to connect the driver to a DALI network. Always combine a DA+ and DA- connector for either data input or data output.

DMX in/LedSync out

Use these connectors when the driver is used in a DMX network. For DMX in, connect the network cable's DMX+, DMX- and DMX shielding wire (the orange/white, orange and brown wire in a CAT5 cable) to the DMX in+, DMX in- and DMX in shield connector respectively. For LedSync out, connect the network cable's DMX+, DMX- and DMX shielding wire to the LedSync out+, LedSync out- and LedSync shield connector respectively.

LED wire length

Maximum wire length from LED driver to LED engine at full load:

AWG value	20	19	18	17	16
Distance (m)	14	18	22	28	36
Distance (ft)	45.9	59	72.2	91.9	118.1



Please observe voltage drop over long wire lengths.



Longer wire lengths increase EMI susceptibility.

LED groups

Indicates the location of the connectors for your LED groups. R(ed) represents channel 1, G(reen) represents channel 2, B(lue) represents channel 3 and W(hite) represents channel 4. The default group color allocation can be changed over the 3-button user interface.

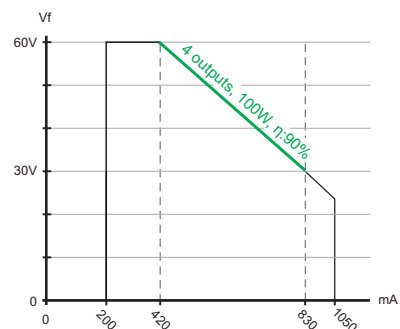

Output voltage vs output current for 4 outputs with symmetrical load

$V_{f \text{ typ}}$ is 57V, LED current ranges from 200mA - 1050mA

LEDcode/NTC

Use these connectors to connect a 47k Ω NTC thermistor for closed loop LED engine temperature control.

Ext in

You have the possibility to connect an external control device (0-10V control device, 10k Ω potentiometer or show selection switch) to the driver's Ext in+ and Ext in- connectors. Configure the driver for use with an external control device over the 3-button user interface.

Connecting 3 LED groups

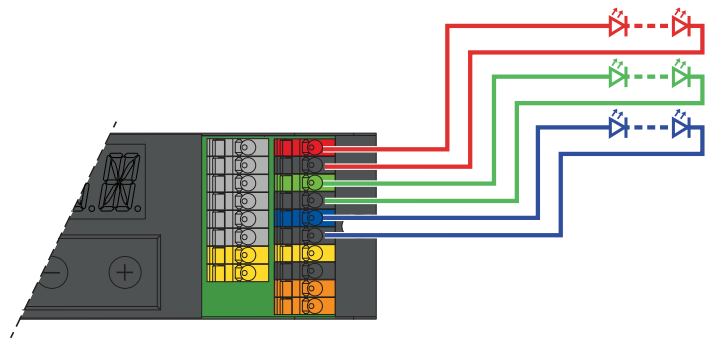
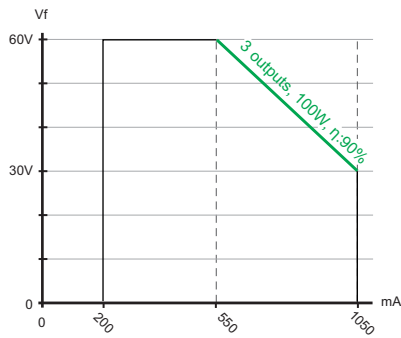

Output voltage vs output current for 3 outputs with symmetrical load
 $V_{f_{typ}}$ is 57V, LED current ranges from 200mA - 1050mA

Connecting 2 LED groups

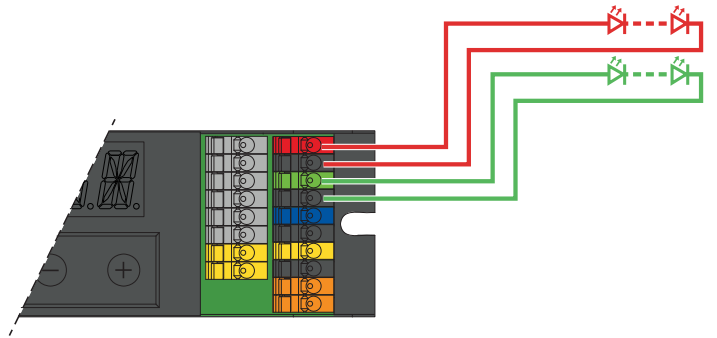
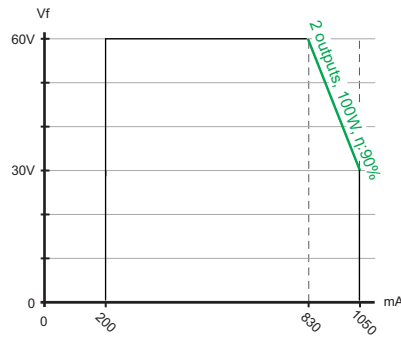

Output voltage vs output current for 2 outputs with symmetrical load
 $V_{f_{typ}}$ is 57V, LED current ranges from 200mA - 1050mA

Connecting 1 LED group

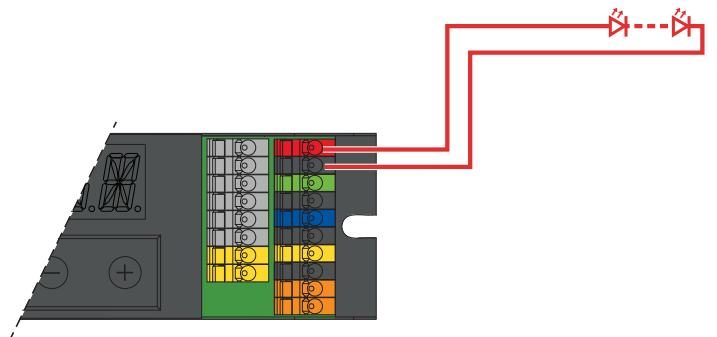
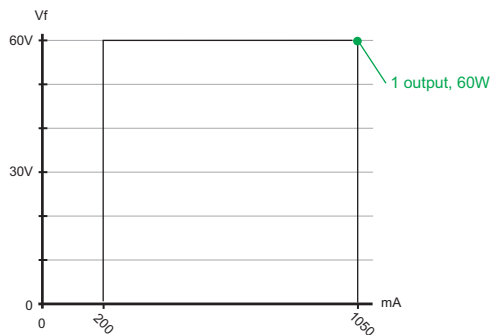

Output voltage vs output current for 1 output
 $V_{f_{typ}}$ is 57V, LED current ranges from 200mA - 1050mA